

SKKT 92, SKKH 92, SKKT 92B



SEMIPACK® 1

Thyristor / Diode Modules

SKKT 92

SKKT 92B

SKKH 92

Features

- Heat transfer through aluminium oxide ceramic isolated metal baseplate
- Hard soldered joints for high reliability
- UL recognized, file no. E 63 532

Typical Applications*

- DC motor control (e. g. for machine tools)
- AC motor soft starters
- Temperature control (e. g. for ovens, chemical processes)
- Professional light dimming (studios, theaters)

1) See the assembly instructions

| V_{RSM} V | V_{RRM}, V_{DRM} V | $I_{TRMS} = 150$ A (maximum value for continuous operation) | | |
|----------------|-------------------------|---|-------------|-------------|
| | | $I_{TAV} = 95$ A (sin. 180; $T_c = 85$ °C) | | |
| 900 | 800 | SKKT 92/08E | SKKT 92B08E | SKKH 92/08E |
| 1300 | 1200 | SKKT 92/12E | SKKT 92B12E | SKKH 92/12E |
| 1500 | 1400 | SKKT 92/14E | SKKT 92B14E | SKKH 92/14E |
| 1700 | 1600 | SKKT 92/16E | SKKT 92B16E | SKKH 92/16E |
| 1900 | 1800 | SKKT 92/18E | SKKT 92B18E | SKKH 92/18E |

| Symbol | Conditions | Values | Units |
|------------------|---|------------------------|------------------|
| I_{TAV} | sin. 180; $T_c = 85$ (100) °C; | 95 (68) | A |
| I_D | P3/180; $T_a = 45$ °C; B2 / B6 | 70 / 85 | A |
| | P3/180F; $T_a = 35$ °C; B2 / B6 | 140 / 175 | A |
| I_{RMS} | P3/180F; $T_a = 35$ °C; W1 / W3 | 190 / 3 * 135 | A |
| I_{TSM} | $T_{vj} = 25$ °C; 10 ms | 2000 | A |
| | $T_{vj} = 125$ °C; 10 ms | 1750 | A |
| i^2t | $T_{vj} = 25$ °C; 8,3 ... 10 ms | 20000 | A ² s |
| | $T_{vj} = 125$ °C; 8,3 ... 10 ms | 15000 | A ² s |
| V_T | $T_{vj} = 25$ °C; $I_T = 300$ A | max. 1,65 | V |
| $V_{T(TO)}$ | $T_{vj} = 125$ °C | max. 0,9 | V |
| r_T | $T_{vj} = 125$ °C | max. 2 | mΩ |
| $I_{DD}; I_{RD}$ | $T_{vj} = 125$ °C; $V_{RD} = V_{RRM}; V_{DD} = V_{DRM}$ | max. 20 | mA |
| t_{gd} | $T_{vj} = 25$ °C; $I_G = 1$ A; $di_G/dt = 1$ A/μs | 1 | μs |
| t_{gr} | $V_D = 0,67 * V_{DRM}$ | 2 | μs |
| $(di/dt)_{cr}$ | $T_{vj} = 125$ °C | max. 150 | A/μs |
| $(dv/dt)_{cr}$ | $T_{vj} = 125$ °C | max. 1000 | V/μs |
| t_q | $T_{vj} = 125$ °C | 100 | μs |
| I_H | $T_{vj} = 25$ °C; typ. / max. | 150 / 250 | mA |
| I_L | $T_{vj} = 25$ °C; $R_G = 33$ Ω; typ. / max. | 300 / 600 | mA |
| V_{GT} | $T_{vj} = 25$ °C; d.c. | min. 3 | V |
| I_{GT} | $T_{vj} = 25$ °C; d.c. | min. 150 | mA |
| V_{GD} | $T_{vj} = 125$ °C; d.c. | max. 0,25 | V |
| I_{GD} | $T_{vj} = 125$ °C; d.c. | max. 6 | mA |
| $R_{th(j-c)}$ | cont.; per thyristor / per module | 0,28 / 0,14 | K/W |
| $R_{th(j-c)}$ | sin. 180; per thyristor / per module | 0,3 / 0,15 | K/W |
| $R_{th(j-c)}$ | rec. 120; per thyristor / per module | 0,32 / 0,16 | K/W |
| $R_{th(c-s)}$ | per thyristor / per module | 0,2 / 0,1 | K/W |
| T_{vj} | | - 40 ... + 125 | °C |
| T_{stg} | | - 40 ... + 125 | °C |
| V_{isol} | a. c. 50 Hz; r.m.s.; 1 s / 1 min. | 3600 / 3000 | V~ |
| M_s | to heatsink | 5 ± 15 % ¹⁾ | Nm |
| M_t | to terminals | 3 ± 15 % | Nm |
| a | | 5 * 9,81 | m/s ² |
| m | approx. | 95 | g |
| Case | SKKT | A 46 | |
| | SKKT ...B | A 48 | |
| | SKKH | A 47 | |



SKKT

SKKH

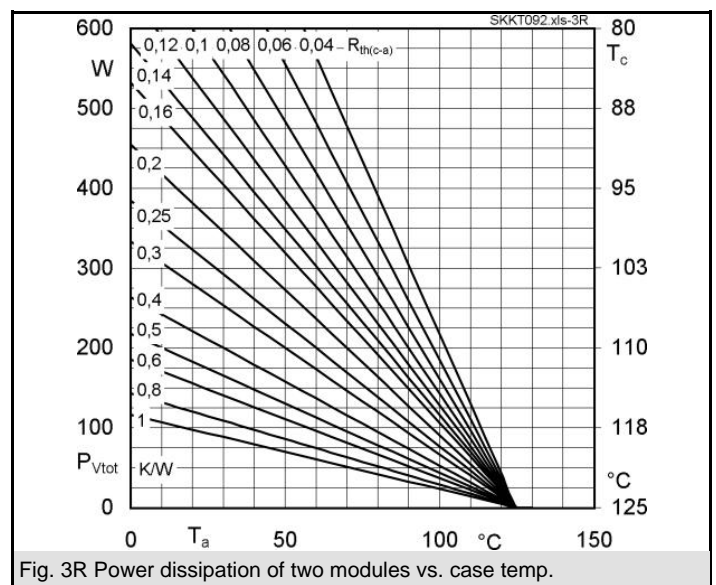
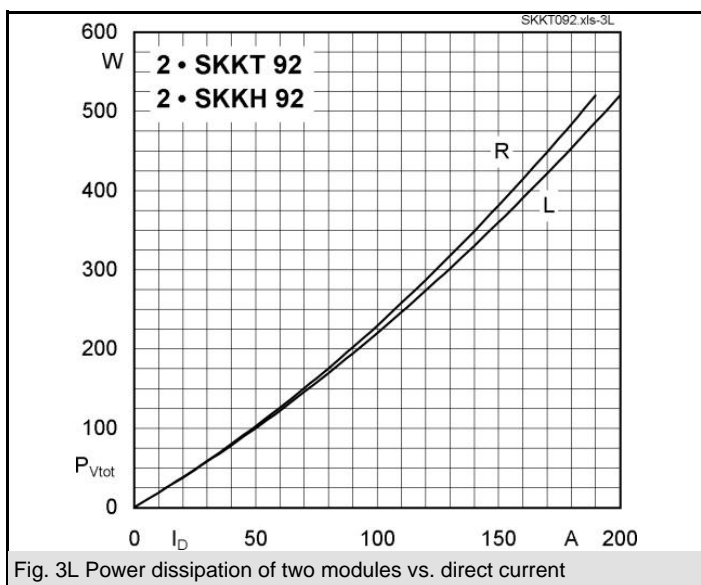
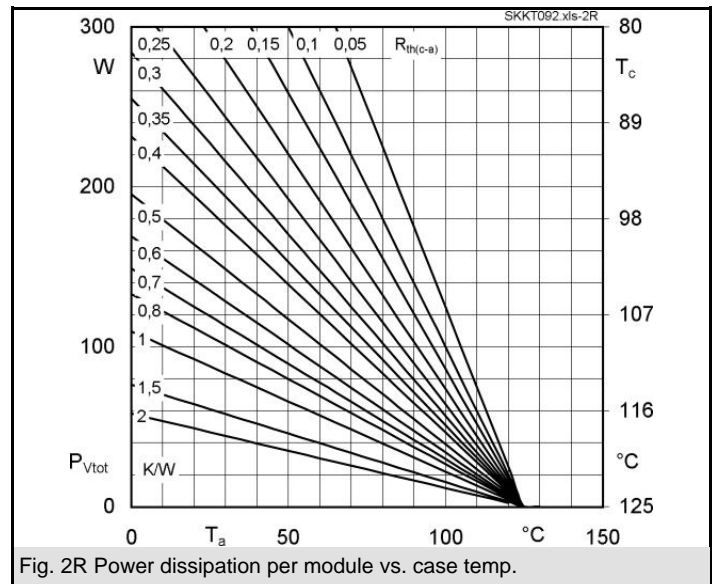
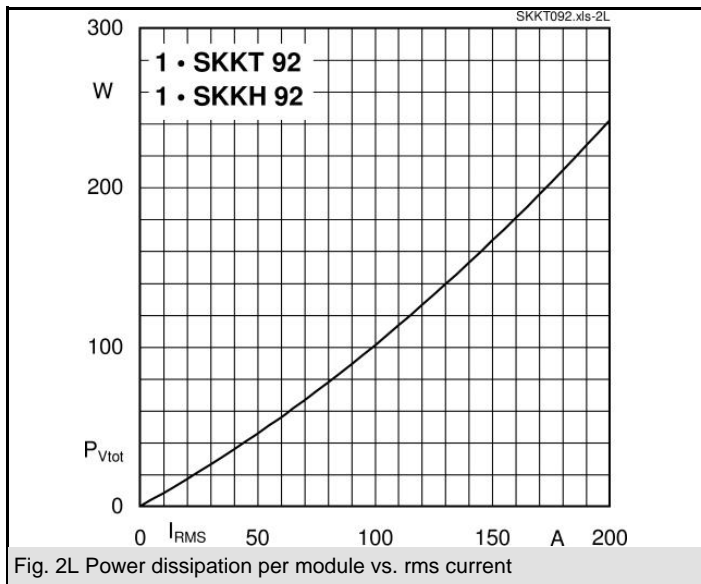
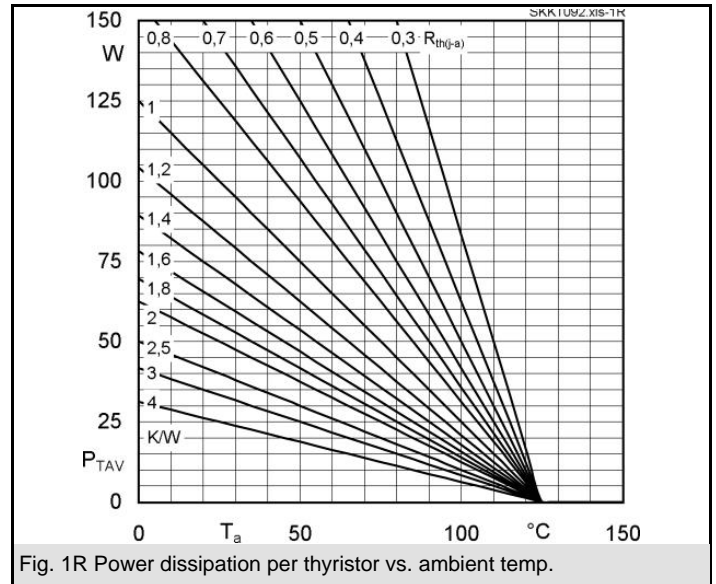
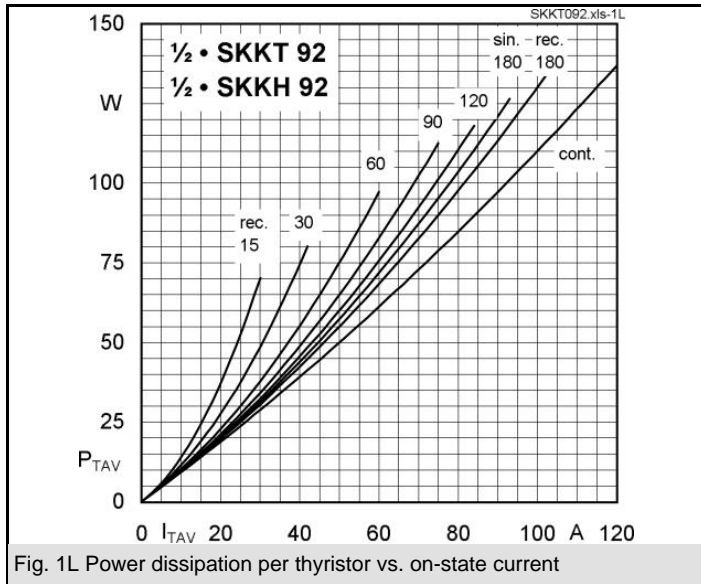

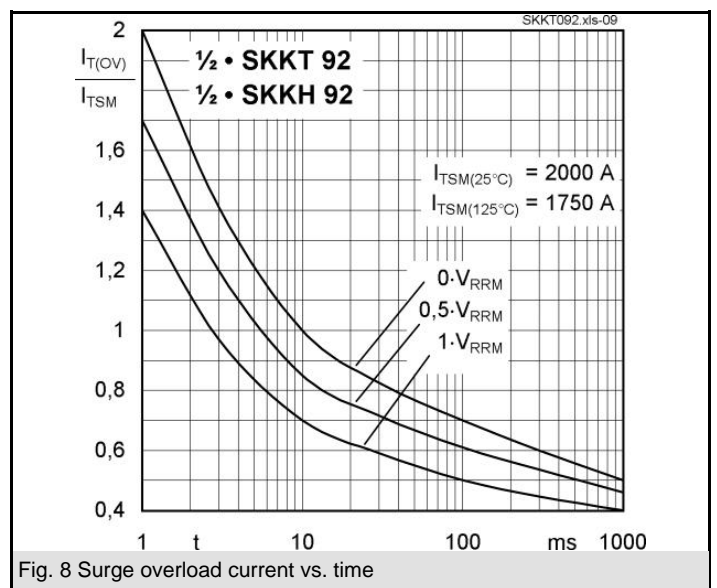
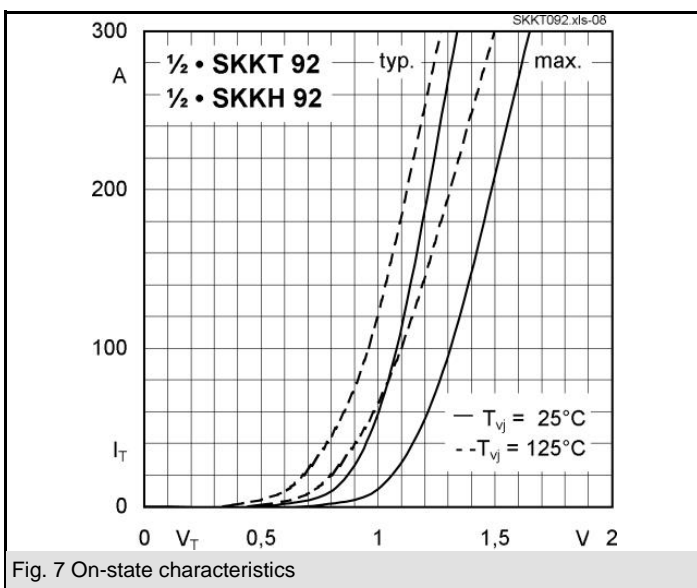
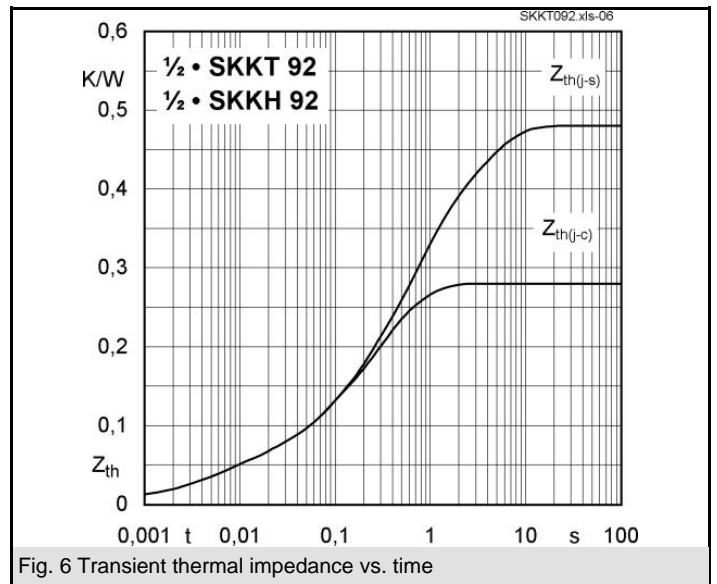
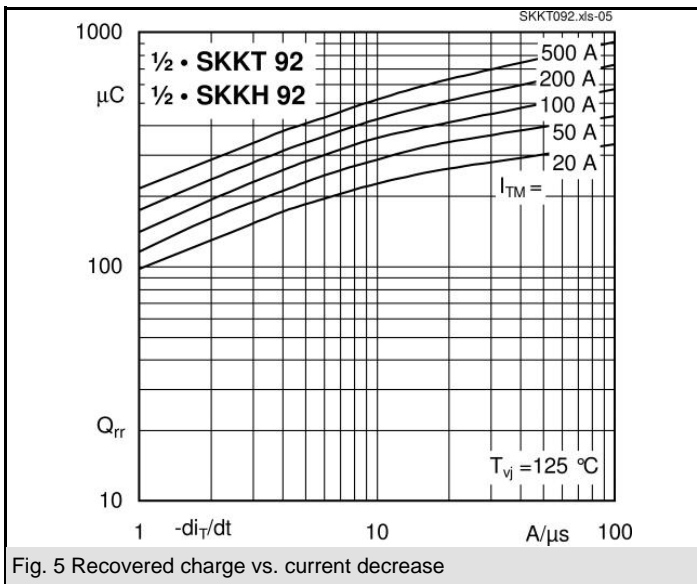
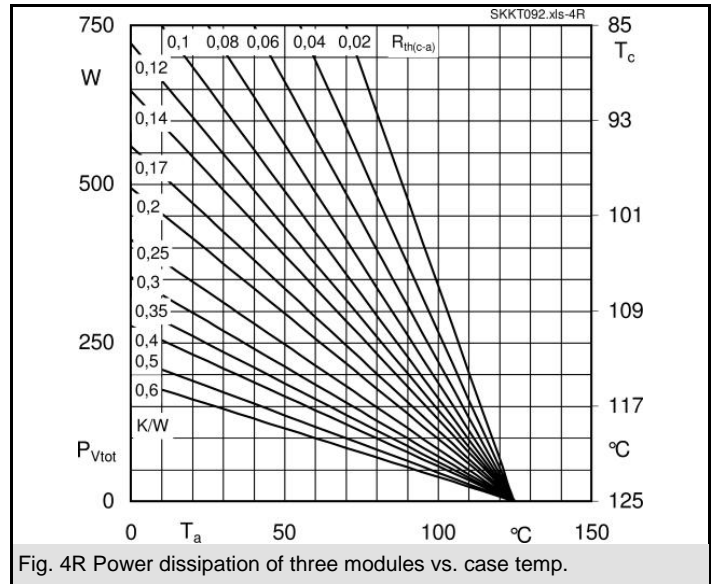
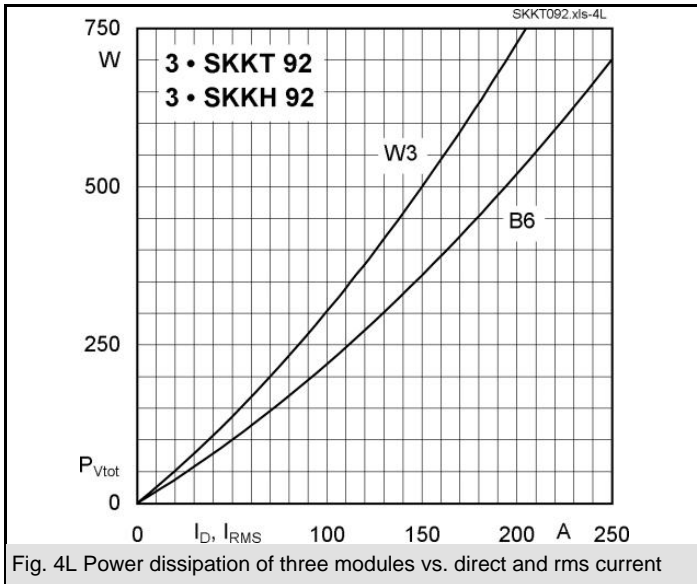

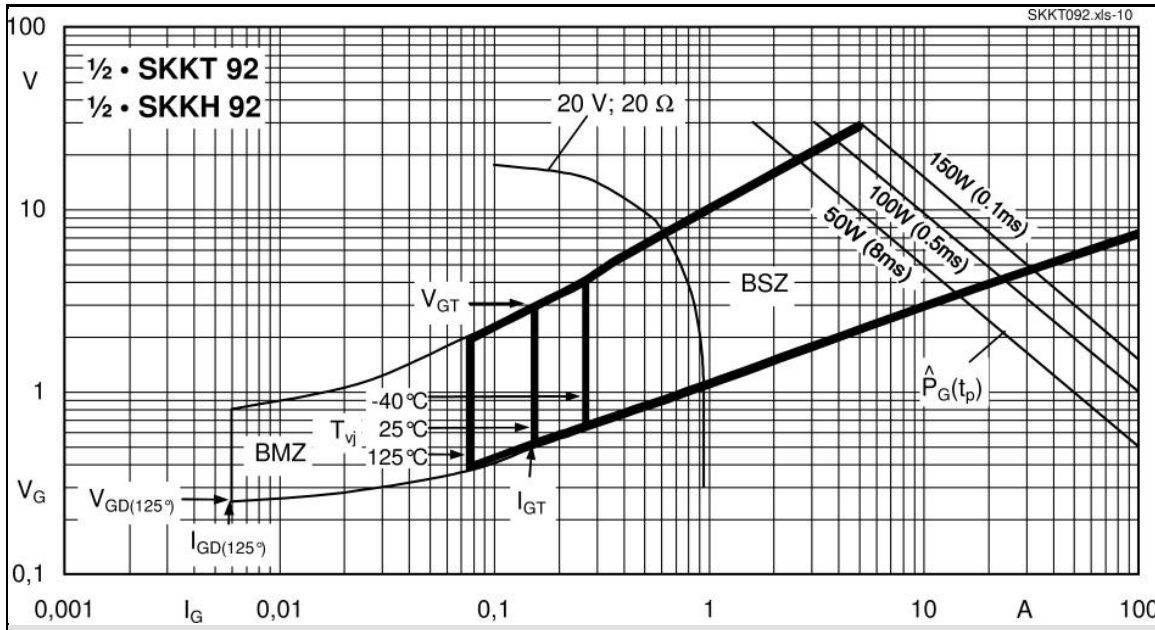
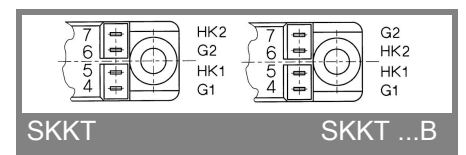
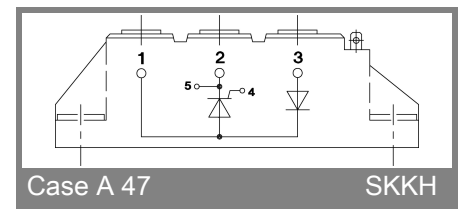
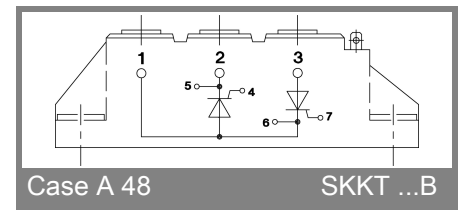
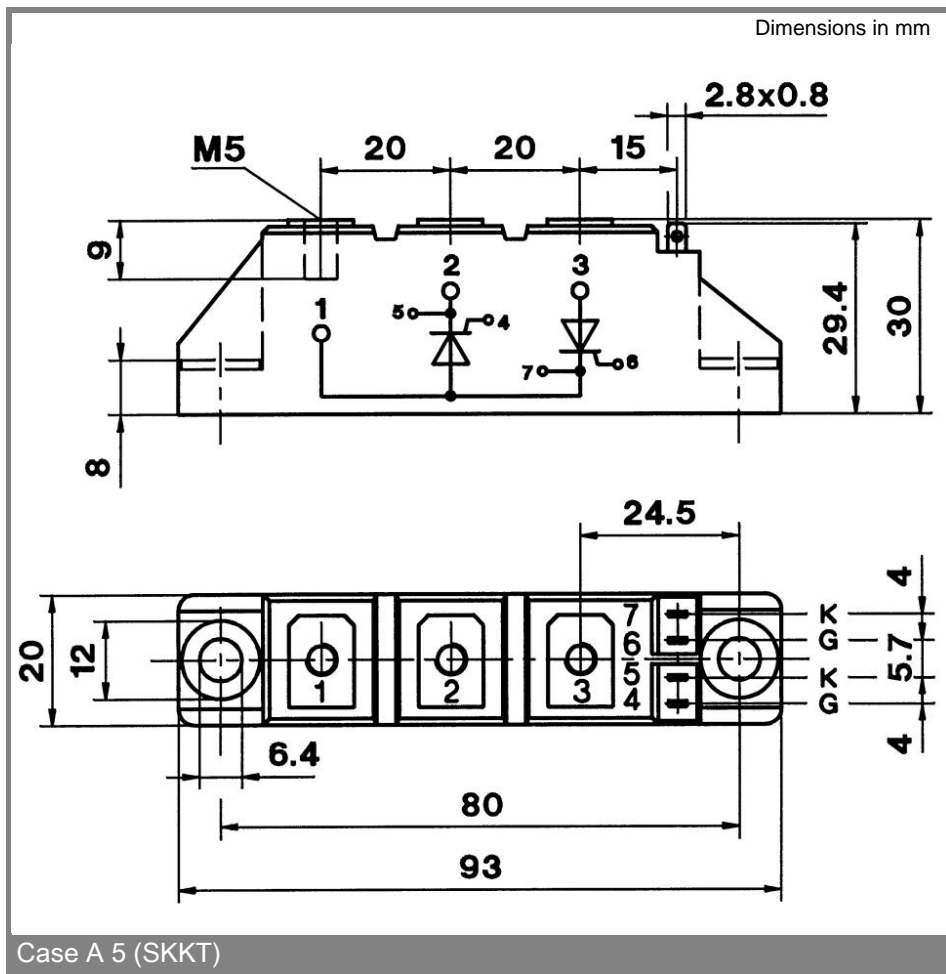

Fig. 9 Gate trigger characteristics



* The specifications of our components may not be considered as an assurance of component characteristics. Components have to be tested for the respective application. Adjustments may be necessary. The use of SEMIKRON products in life support appliances and systems is subject to prior specification and written approval by SEMIKRON. We therefore strongly recommend prior consultation of our personal.